

panel mounting socket outlet, straight - flange 107x100 fixing centers 85x77

Product description

Order number	1396
EAN/pcs	4024941013963
Product Group	GT panel mounting socket outlet straight
Amperage	63A
Poles	3p (2P+PE)
Earth 'Clock' Position	6 h
Voltage	200 up to 250V
Frequency	50 and 60Hz
Protection	IP67
Color code	blue RAL 5015
Connection Design	screw terminal as box terminal with Kontex-contact
Max. conductor	25.0 mm ²



Further Information

Material

Material of Enclosure	Polyamide
Contact / Contact Carrier	contact carrier made of Polyamide, contacts are brass nickel plated
Weight/pcs	0.456 kg
Packaging unit	5 pcs

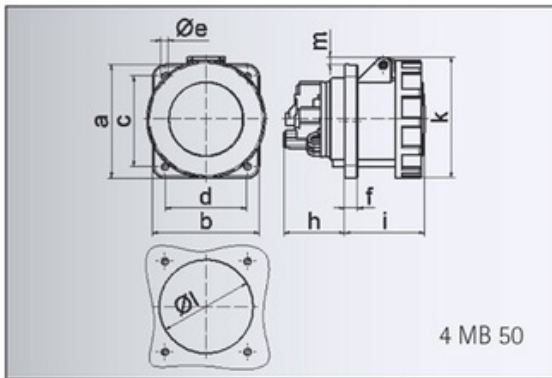

Ampere	63	63	63
Polzahl	3	4	5
a	107,0	107,0	107,0
b	100,0	100,0	100,0
c	85,0	85,0	85,0
d	77,0	77,0	77,0
e ø	6,5	6,5	6,5
f	12,0	12,0	12,0
h	56,5	56,5	56,5
i	76,0	76,0	76,0
k	113,0	113,0	113,0
l ø	88,0	88,0	88,0
m	7,0	7,0	7,0
Leiter mm ² min	6	6	6
Leiter mm ² max	25	25	25